



**ULTIMATRON
FRANCE**

**5 YEARS
WARRANTY**



Technical sheet

ULTIMATRON LiFePO4 Smart BMS Lithium Battery UBL-12-200

Compared with traditional batteries, our lithium iron phosphate batteries (LiFePO4) have many advantages:

- 5 years manufacturer's warranty
- The safest technology, without risk of fire or explosion
- Long service life
- Constantly improving storage capacity
- High stability even under extreme loads
- No memory effect, no need for full charge and discharge cycles
- High performance even under extreme conditions
- Deep and regular discharge and charging efficiency
- Small size and light weight



Integrated Battery Management System (BMS)

To allow the control and the charge of the different elements of an accumulator battery and to protect it against overcharging, overvoltages and overheating.



Note: Series and parallel connection for 12V, 24V, 36V, 48V applications.



Integrated Bluetooth 4.0 monitoring



You have all important battery data always on your smartphone or tablet. The application displays the data in real time.





ULTIMATRON LiFePO4 Smart BMS Lithium Battery UBL-12-200

ELECTRICAL PERFORMANCE

Nominal Voltage	12.8V
Nominal Capacity	200Ah
Capacity @ 20A	600min
Energy	2560Wh
Resistance	≤15 mΩ @ 50% SOC
Self Discharge	<3% / Month
Number of Cycles	>6000 at 80% DoD

CHARGE PERFORMANCE

Recommended Charge Current	60A
Maximum Charge Current	100A
Recommended Charge Voltage	14.6V
Charge Cut-Off Voltage	14.6V (2000ms)
Reconnect Voltage	≤13.8V
Balancing Voltage	>12.8V

DISCHARGE PERFORMANCE

Maximum continuous Discharge Current	150A
Peak Discharge Cut-Off Current	450A (200~500ms)
Discharge Cut-Off Voltage	10V (2000 ms)
Reconnect Voltage	>11.2V
Short Circuit Protection	1000-2000A ± 400A (200 ~ 800 μs)

TEMPERATURE PERFORMANCE

Discharge Temperature	-20 ~ 75 °C
Charge Temperature	0 ~ 50 °C
Storage Temperature	-5 ~ 35 °C

DIMENSION

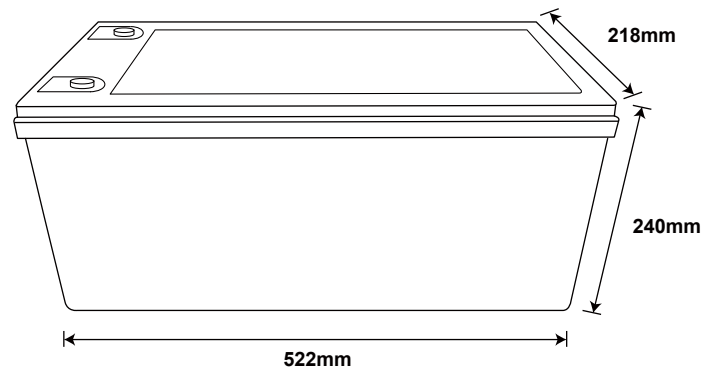

Dimensions	L522 * W240 * H218mm
------------	----------------------

MECHANICAL PERFORMANCE

Weight	22.7kg
Terminal Type	M8
Terminal Torque	80 ~ 100 in-lbs (9 ~ 11 N-m)
Case Material	ABS
Ingress Protection Code	IP65
Bluetooth	Bluetooth 4.0 with smartphone App

COMPLIANCE

Certifications	CE UN38.3 UL1642 & IEC62133
Shipping Classification	UN 3480, CLASS 9